

男子団体

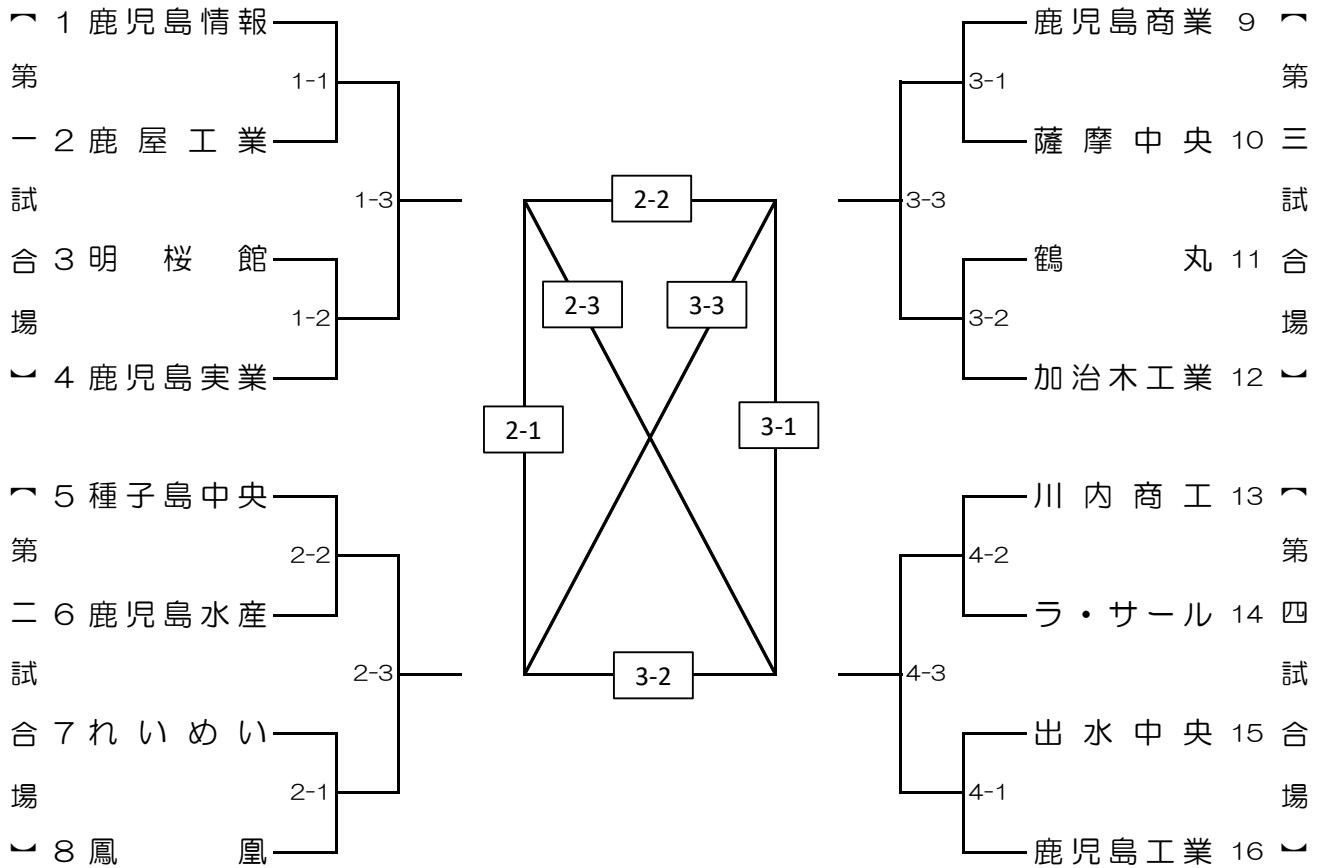

女子団体

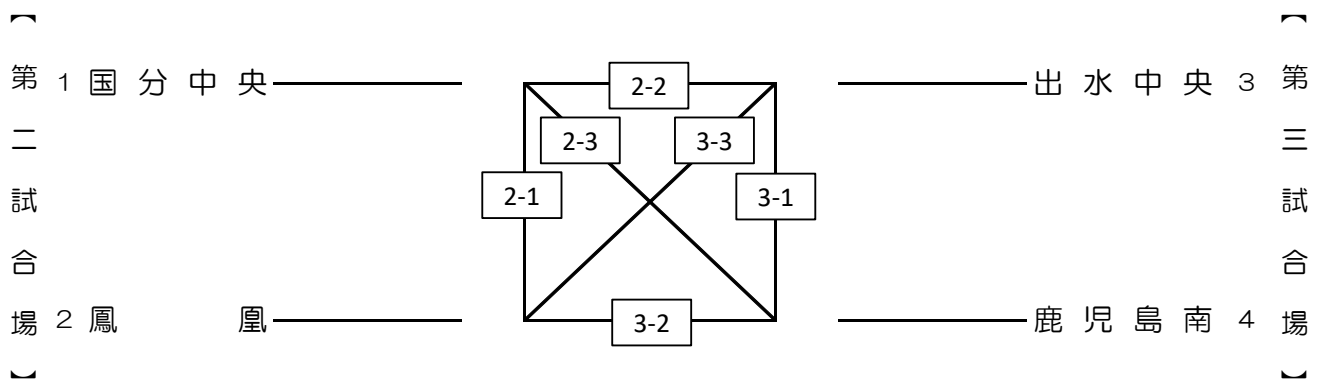

48kg級

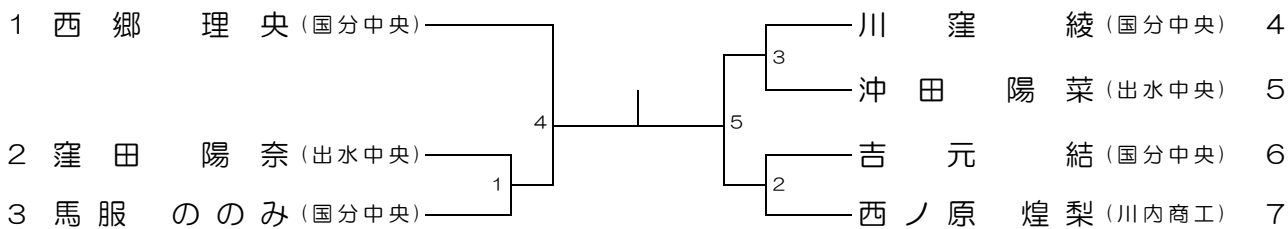

52kg級

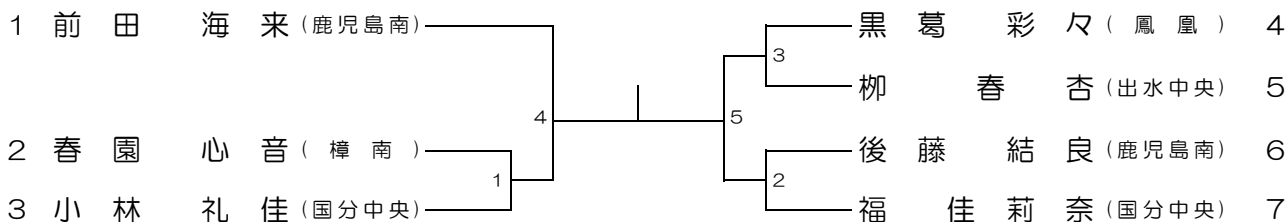

57kg級

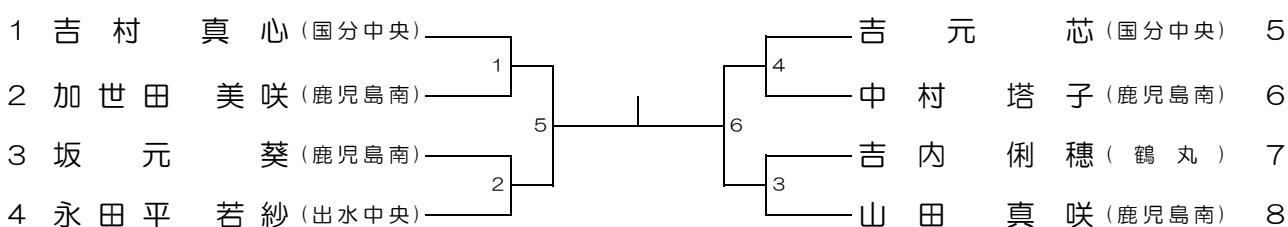

63kg級

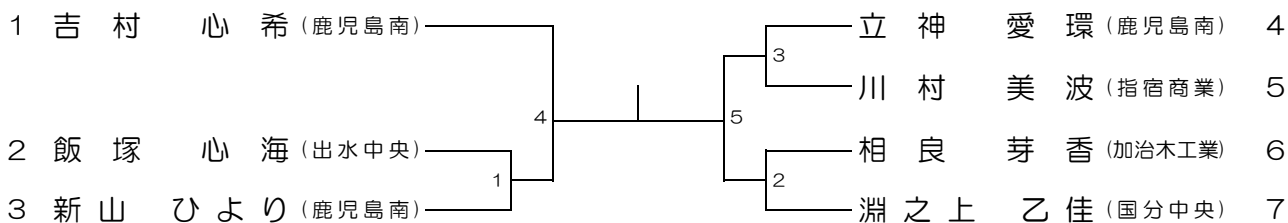

70kg級

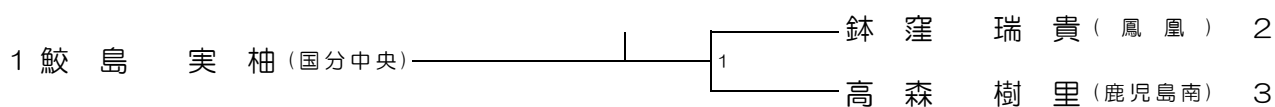

78kg級

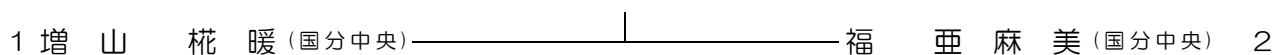

78kg超級

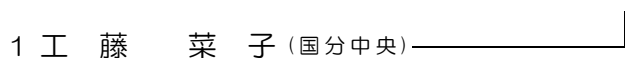

60kg級

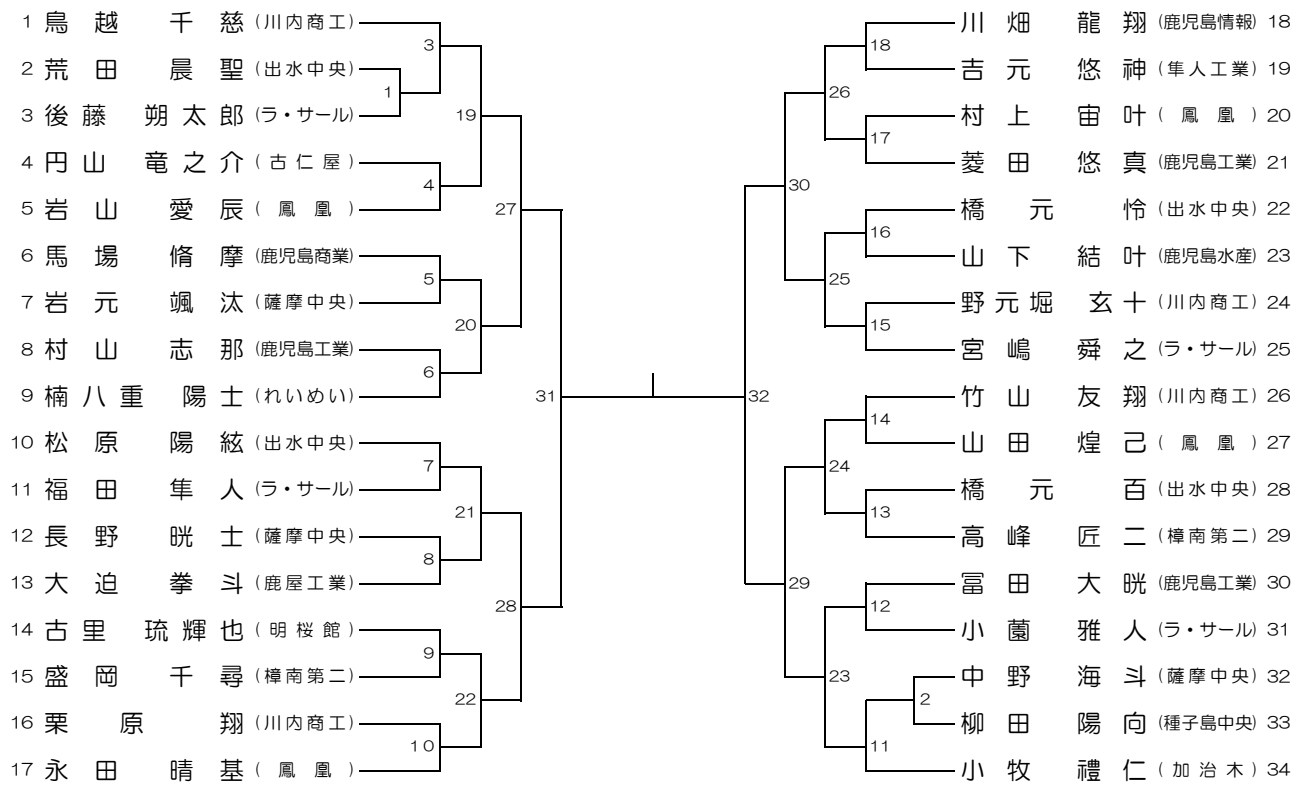

66kg級

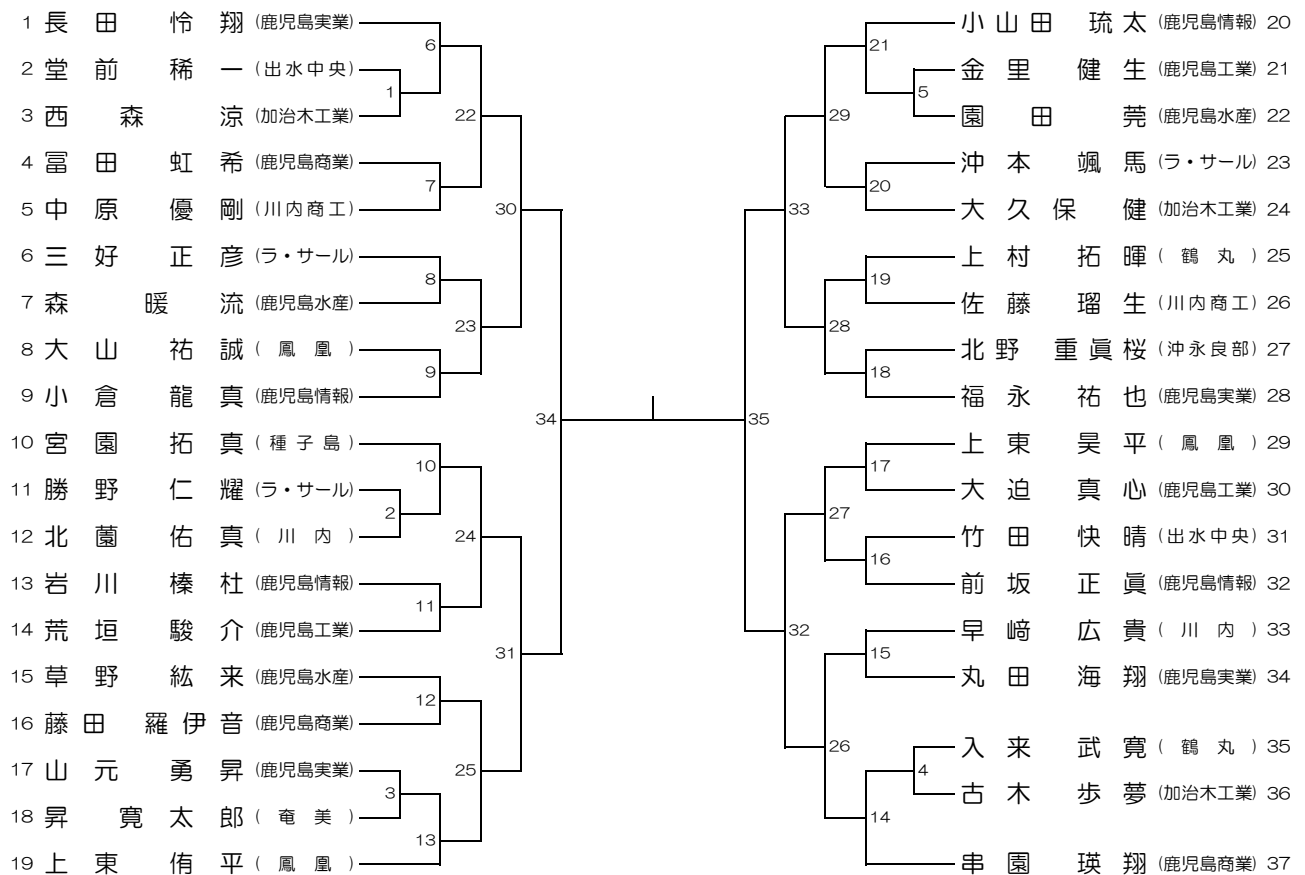

73kg級

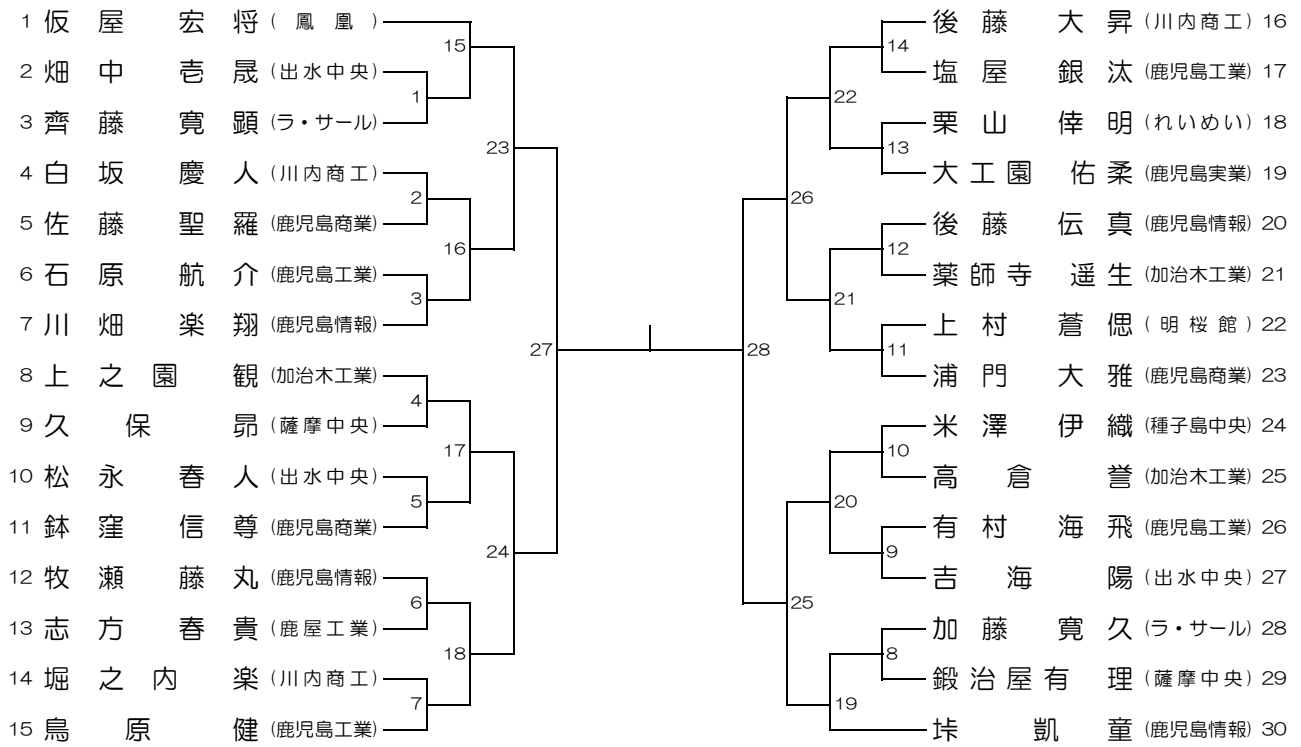

81kg級

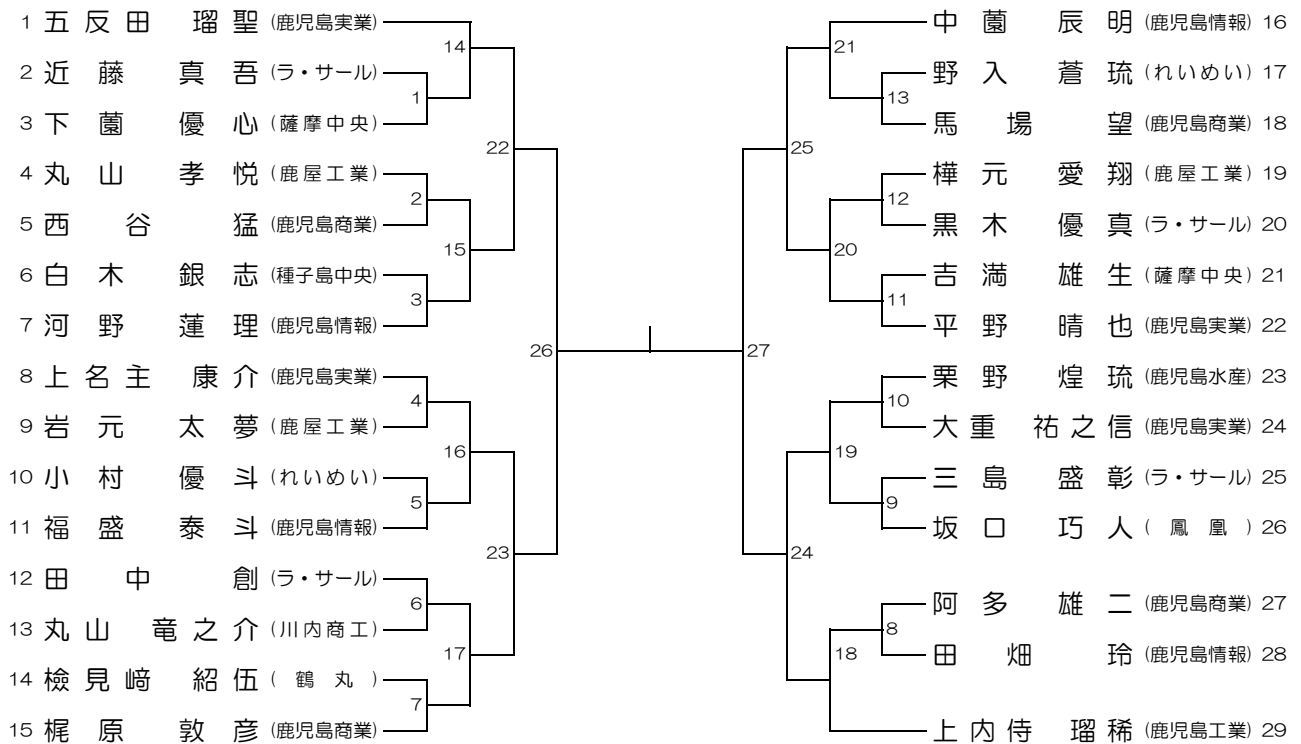

90kg級

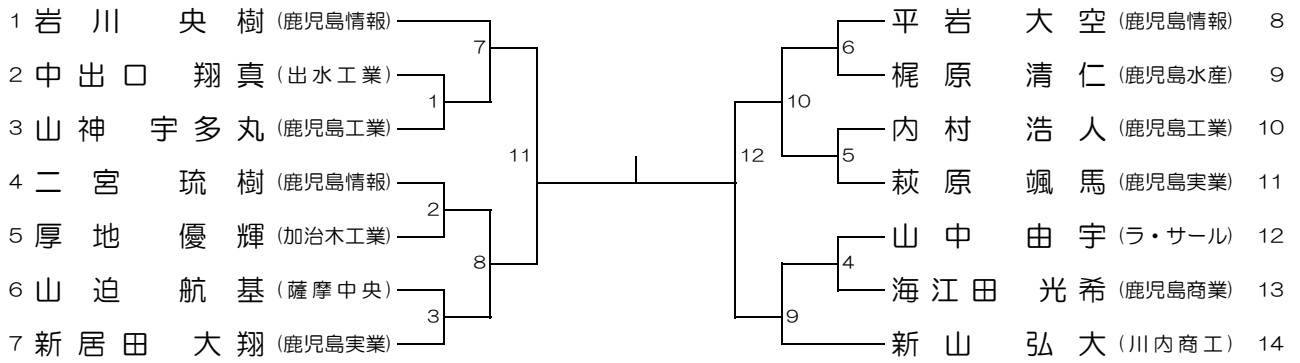

100kg級

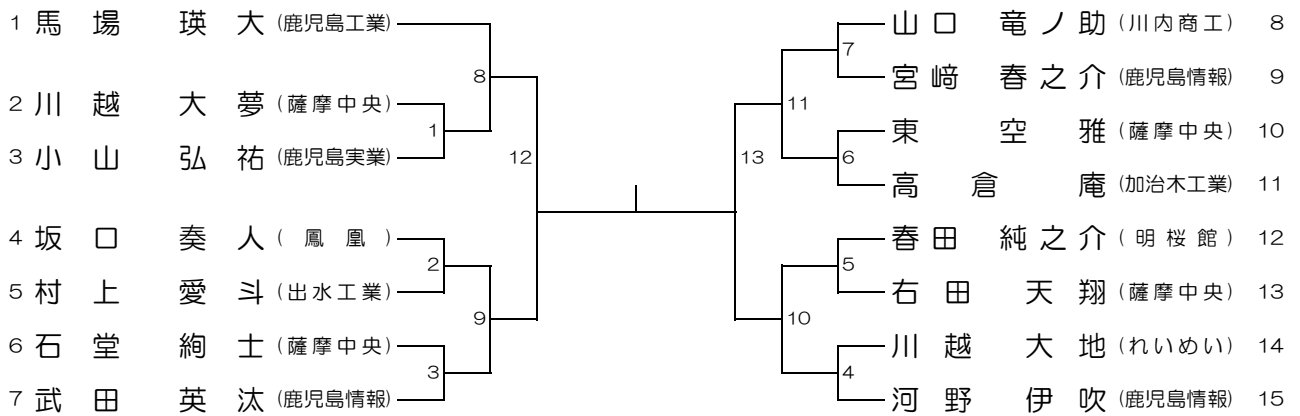

100kg超級

