

コート No.	MT:男子学校対抗				WT:女子学校対抗												コート No.												
	9:00	9:30			11:00				12:10				13:20					14:30				15:40				16:50			
1		MT101			MT 201				MT 304				MT 308															1	
2		MT102																						MT 5～8位決定			MT 5・6位決定	2	
3		MT103			MT 204				MT 303				MT 307															3	
4		MT104																										4	
5		MT105			MT 205				MT 302				MT 306															5	
6		MT106																										6	
7		MT107			MT 207				MT 301				MT 305															7	
8		MT108																										8	
9		MT202			MT 208			WT 201				MT 401		MT 403										MT決勝リーグ① A-D				9	
10		MT203																										10	
11		MT206			MT 209			WT 202				MT 402		MT 404										MT決勝リーグ① B-C				11	
12	開始式	WT101																										12	
13		WT102			MT 210			WT 203				WT 301		WT決勝リーグ① A-D															13
14		WT103																											14
15		WT104			MT 211			WT 204				WT 302		WT決勝リーグ① B-C															15
16		WT105																											16
17		WT106			MT 212			WT 205																					17
18		WT107																											18
19		WT108			MT 213			WT 206				WT 303																	19
20		WT109																											20
21		WT110			MT 214			WT 207				WT 304																	21
22		WT111																											22
23		WT112			MT 215			WT 208																					23
24		WT113																											24
					MT 216																								

←コートが空き次第11:00～

※時間は目安であり、前後することもあります。コートを変更する場合があります。

コート No.	MD:男子ダブルス			WD:女子ダブルス			MT:男子学校対抗			WT:女子学校対抗			コート No.								
	9:00	9:30	10:00	10:30	11:00	11:30	12:00	12:30	13:00	13:30	14:00	14:30		15:00	15:30	16:00	16:30	17:00	17:30		
1	MD101	MD208	MD201	MD231	MD243	MD255	MD313													1	
2	MD102	MD209	MD217	MD232	MD244	MD256	MD314														2
3	MD103	MD210	MD221	MD233	MD245	MD257	MD315														3
4	MD104	MD211	MD222	MD234	MD246	MD258	MD316														4
5	MD105	MD212	MD223	MD235	MD247	MD259	MD317														5
6	MD106	MD213	MD224	MD236	MD248	MD260	MD318														6
7	MD202	MD214	MD225	MD237	MD249	MD261	MD319														7
8	MD203	MD215	MD226	MD238	MD250	MD262	MD320														8
9	MD204	MD216	MD227	MD239	MD251	MD263		MT決勝リーグ② ①A-Dの勝者-①B-Cの敗者			MT決勝リーグ③ ①A-Dの勝者-①B-Cの勝者									9	
10	MD205	MD218	MD228	MD240	MD252	MD264		MT決勝リーグ② ①B-Cの勝者-①A-Dの敗者			MT決勝リーグ③ ①A-Dの敗者-①B-Cの敗者										10
11	MD206	MD219	MD229	MD241	MD253	MD301		WT決勝リーグ② ①A-Dの勝者-①B-Cの敗者			WT決勝リーグ③ ①A-Dの勝者-①B-Cの勝者										11
12	MD207	MD220	MD230	MD242	MD254	MD302		WT決勝リーグ② ①B-Cの勝者-①A-Dの敗者			WT決勝リーグ③ ①A-Dの敗者-①B-Cの敗者										12
13	WD101	WD113	WD125	WD207	WD219	MD303	MD321	WT決勝リーグ② ①A-Dの勝者-①B-Cの敗者			WT決勝リーグ③ ①A-Dの勝者-①B-Cの勝者										13
14	WD102	WD114	WD126	WD208	WD220	MD304	MD322	WT決勝リーグ② ①B-Cの勝者-①A-Dの敗者			WT決勝リーグ③ ①A-Dの敗者-①B-Cの敗者										14
15	WD103	WD115	WD127	WD209	WD221	MD305	MD323	WT決勝リーグ② ①A-Dの勝者-①B-Cの敗者			WT決勝リーグ③ ①A-Dの勝者-①B-Cの勝者										15
16	WD104	WD116	WD128	WD210	WD222	MD306	MD324	WT決勝リーグ② ①B-Cの勝者-①A-Dの敗者			WT決勝リーグ③ ①A-Dの敗者-①B-Cの敗者										16
17	WD105	WD117	WD129	WD211	WD223	MD307	MD325														17
18	WD106	WD118	WD130	WD212	WD224	MD308	MD326														18
19	WD107	WD119	WD201	WD213	WD225	MD309	MD327														19
20	WD108	WD120	WD202	WD214	WD226	MD310	MD328														20
21	WD109	WD121	WD203	WD215	WD227	MD311	MD329														21
22	WD110	WD122	WD204	WD216	WD228	MD312	MD330														22
23	WD111	WD123	WD205	WD217	WD229	WD231	MD331														23
24	WD112	WD124	WD206	WD218	WD230	WD232	MD332														24

※時間は目安であり、前後することもあります。コートを変更する場合があります。

コート No.	MS:男子シングルス			WS:女子シングルス							MD:男子ダブルス			WD:女子ダブルス				コート No.		
	9:00	9:20	9:40	10:00	10:20	10:40	11:00	11:20	11:40	12:00	12:30	13:00	13:30	14:00	14:30	15:00	15:30		16:00	16:30
1	MS1001	MS1013	MS1025	MS2004	MS2016	MS2028	MS2040	MS2057	MS2081	MS2105										1
2	MS1002	MS1014	MS1026	MS2005	MS2017	MS2029	MS2041	MS2058	MS2082	MS2106										2
3	MS1003	MS1015	MS1027	MS2006	MS2018	MS2030	MS2042	MS2059	MS2083	MS2107	WD301	MD401	MD508							3
4	MS1004	MS1016	MS1028	MS2007	MS2019	MS2031	MS2043	MS2060	MS2084	MS2108	WD302	MD402	MD507			MD3位決定				4
5	MS1005	MS1017	MS1029	MS2008	MS2020	MS2032	MS2044	MS2061	MS2085	MS2109	WD303	MD403	MD506							5
6	MS1006	MS1018	MS1030	MS2009	MS2021	MS2033	MS2045	MS2062	MS2086	MS2110	WD304	MD404	MD505							6
7	MS1007	MS1019	MS1031	MS2010	MS2022	MS2034	MS2046	MS2063	MS2087	MS2111										7
8	MS1008	MS1020	MS1032	MS2011	MS2023	MS2035	MS2047	MS2064	MS2088	MS2112										8
9	MS1009	MS1021	MS1033	MS2012	MS2024	MS2036	MS2048	MS2065	MS2089	MS2113	WD305	MD405	MD504	MD601						9
10	MS1010	MS1022	MS2001	MS2013	MS2025	MS2037	MS2049	MS2066	MS2090	MS2114	WD306	MD406	MD503	MD602	MD701					10
11	MS1011	MS1023	MS2002	MS2014	MS2026	MS2038	MS2050	MS2067	MS2091	MS2115	WD307	MD407	MD502	MD603		MD801				11
12	MS1012	MS1024	MS2003	MS2015	MS2027	MS2039	MS2051	MS2068	MS2092	MS2116	WD308	MD408	MD501	MD604	MD702					12
13	WS101	WS113	WS125	WS137	WS149	WS161	MS2052	MS2069	MS2093	MS2117	WD309	MD409	WD408	WD501	WD601					13
14	WS102	WS114	WS126	WS138	WS150	WS162	MS2053	MS2070	MS2094	MS2118	WD310	MD410	WD407	WD502		WD701				14
15	WS103	WS115	WS127	WS139	WS151	WS163	MS2054	MS2071	MS2095	MS2119	WD311	MD411	WD406	WD503	WD602					15
16	WS104	WS116	WS128	WS140	WS152	WS164	MS2055	MS2072	MS2096	MS2120	WD312	MD412	WD405	WD504						16
17	WS105	WS117	WS129	WS141	WS153	WS165	MS2056	MS2073	MS2097	MS2121										17
18	WS106	WS118	WS130	WS142	WS154	WS166	WS173	MS2074	MS2098	MS2122										18
19	WS107	WS119	WS131	WS143	WS155	WS167	WS174	MS2075	MS2099	MS2123	WD313	MD413	WD404							19
20	WS108	WS120	WS132	WS144	WS156	WS168	WS175	MS2076	MS2100	MS2124	WD314	MD414	WD403							20
21	WS109	WS121	WS133	WS145	WS157	WS169	WS176	MS2077	MS2101	MS2125	WD315	MD415	WD402			WD3位検定				21
22	WS110	WS122	WS134	WS146	WS158	WS170	WS177	MS2078	MS2102	MS2126	WD316	MD416	WD401							22
23	WS111	WS123	WS135	WS147	WS159	WS171	WS178	MS2079	MS2103	MS2127										23
24	WS112	WS124	WS136	WS148	WS160	WS172	WS179	MS2080	MS2104	MS2128										24

※時間は目安であり、前後することもあります。コートを変更する場合があります。

コート No.	MS:男子シングルス			WS:女子シングルス																コート No.
	9:00	9:20	9:40	10:00	10:20	10:40	11:00	11:20	11:40	12:00	12:30	13:00	13:30	14:00	14:30	15:00				
1	MS3001	MS3013	MS3025	MS3037	MS3049	MS3061	MS4009	MS4021	MS5001											1
2	MS3002	MS3014	MS3026	MS3038	MS3050	MS3062	MS4010	MS4022	MS5002		MS6005				MS3位決定					2
3	MS3003	MS3015	MS3027	MS3039	MS3051	MS3063	MS4011	MS4023	MS5003		MS6006									3
4	MS3004	MS3016	MS3028	MS3040	MS3052	MS3064	MS4012	MS4024	MS5004	MS5013	MS6007			MS5位決定	MS5位決定					4
5	MS3005	MS3017	MS3029	MS3041	MS3053	MS4001	MS4013	MS4025	MS5005	MS5014	MS6008									5
6	MS3006	MS3018	MS3030	MS3042	MS3054	MS4002	MS4014	MS4026	MS5006	MS5015				MS5位決定						6
7	MS3007	MS3019	MS3031	MS3043	MS3055	MS4003	MS4015	MS4027	MS5007	MS5016										7
8	MS3008	MS3020	MS3032	MS3044	MS3056	MS4004	MS4016	MS4028	MS5008											8
9	MS3009	MS3021	MS3033	MS3045	MS3057	MS4005	MS4017	MS4029	MS5009		MS6001		MS7001							9
10	MS3010	MS3022	MS3034	MS3046	MS3058	MS4006	MS4018	MS4030	MS5010		MS6002		MS7002	MS8001						10
11	MS3011	MS3023	MS3035	MS3047	MS3059	MS4007	MS4019	MS4031	MS5011		MS6003		MS7003		MS9001					11
12	MS3012	MS3024	MS3036	MS3048	MS3060	MS4008	MS4020	MS4032	MS5012		MS6004		MS7004	MS8002						12
13	WS201	WS213	WS225	WS237	WS249	WS261	WS309	WS321	WS401		WS501		WS601	WS701						13
14	WS202	WS214	WS226	WS238	WS250	WS262	WS310	WS322	WS402		WS502		WS602		WS801					14
15	WS203	WS215	WS227	WS239	WS251	WS263	WS311	WS323	WS403		WS503		WS603	WS702						15
16	WS204	WS216	WS228	WS240	WS252	WS264	WS312	WS324	WS404		WS504		WS604							16
17	WS205	WS217	WS229	WS241	WS253	WS301	WS313	WS325	WS405											17
18	WS206	WS218	WS230	WS242	WS254	WS302	WS314	WS326	WS406		WS505				WS3位決定					18
19	WS207	WS219	WS231	WS243	WS255	WS303	WS315	WS327	WS407		WS506									19
20	WS208	WS220	WS232	WS244	WS256	WS304	WS316	WS328	WS408	WS413	WS507			WS5位決定	WS5位決定					20
21	WS209	WS221	WS233	WS245	WS257	WS305	WS317	WS329	WS409	WS414	WS508									21
22	WS210	WS222	WS234	WS246	WS258	WS306	WS318	WS330	WS410	WS415				WS5位決定						22
23	WS211	WS223	WS235	WS247	WS259	WS307	WS319	WS331	WS411	WS416										23
24	WS212	WS224	WS236	WS248	WS260	WS308	WS320	WS332	WS412											24

※時間は目安であり、前後することもあります。コートを変更する場合があります。

男子学校対抗

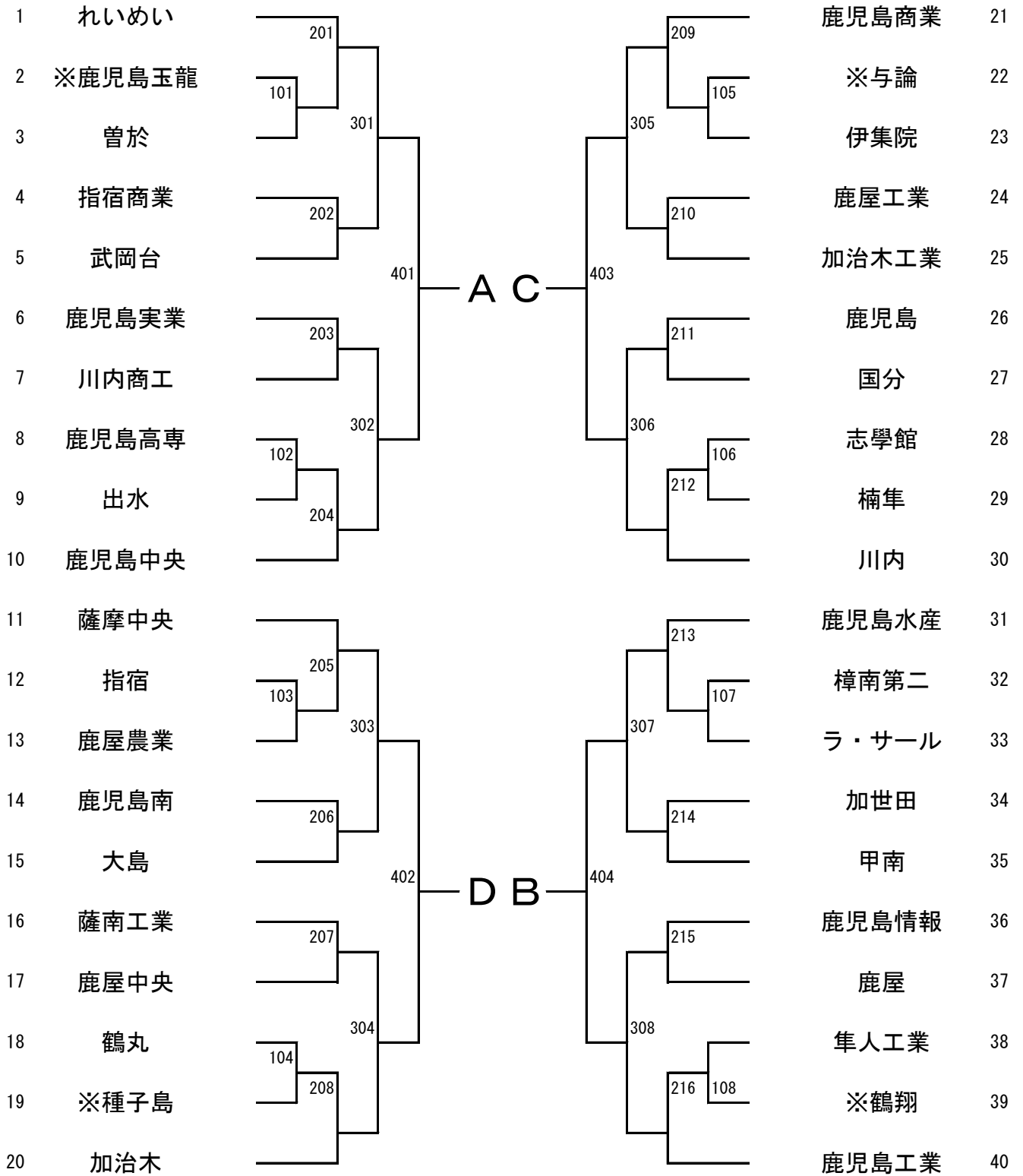

女子学校対抗

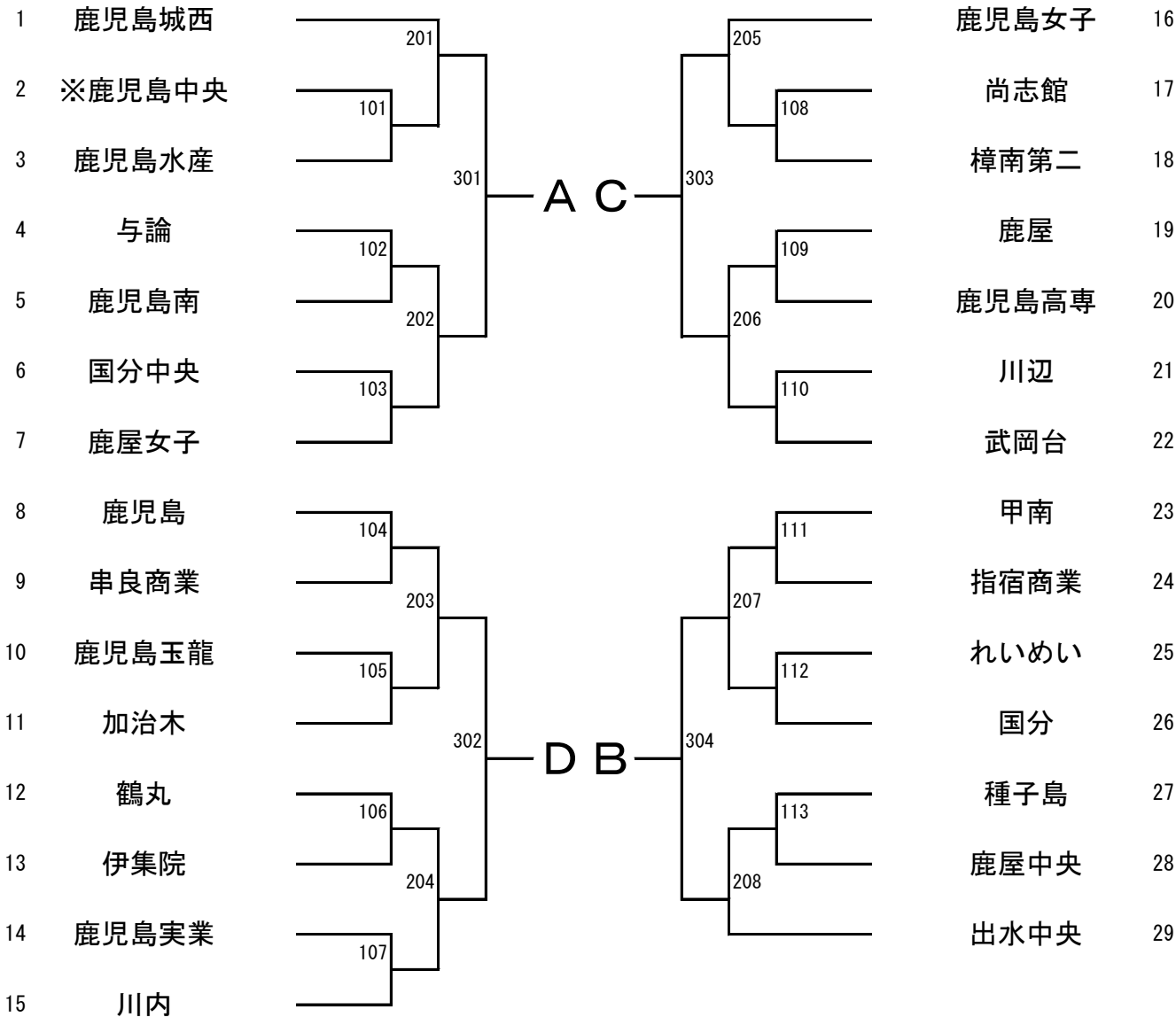

男子シングルス (1)

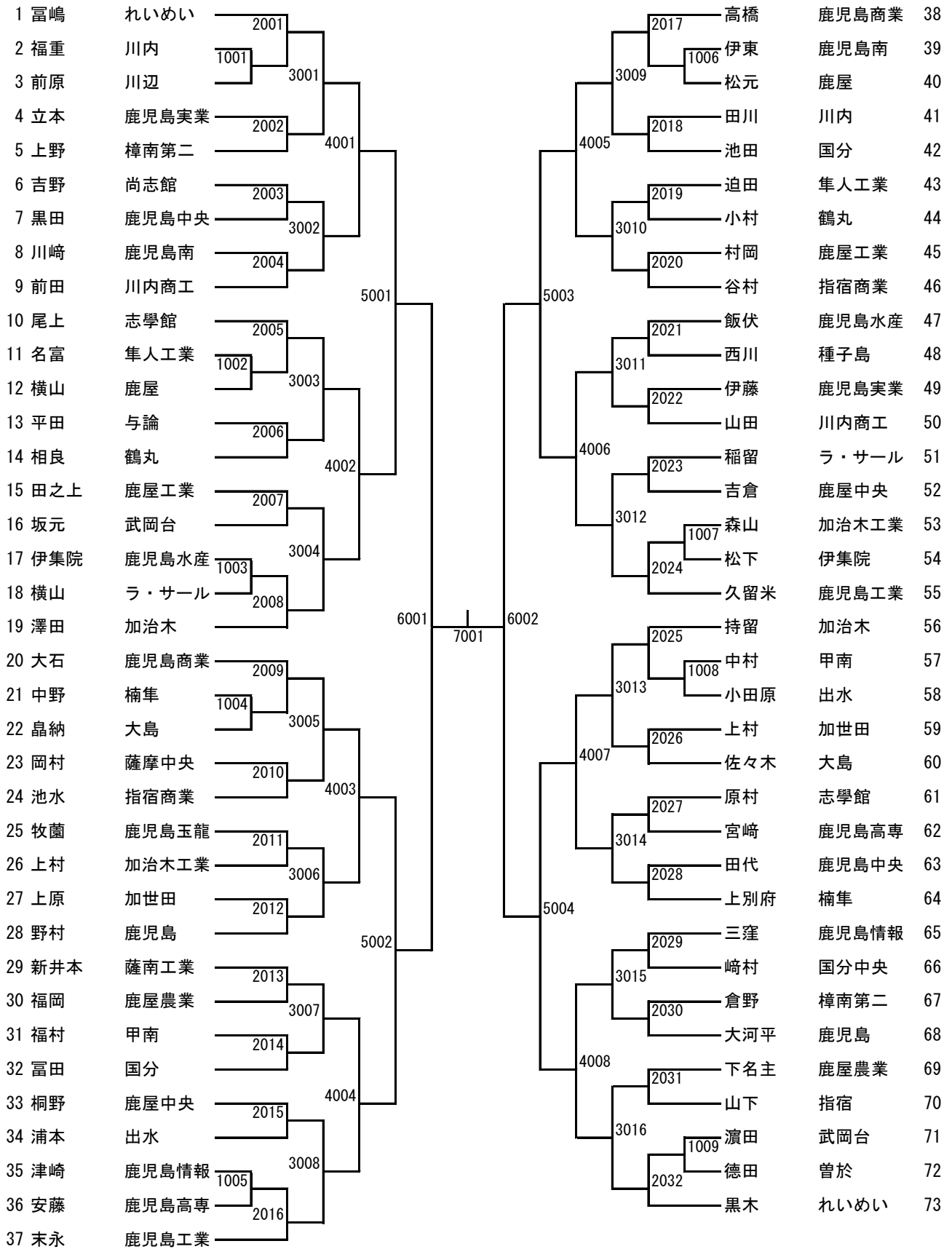

男子シングルス (2)

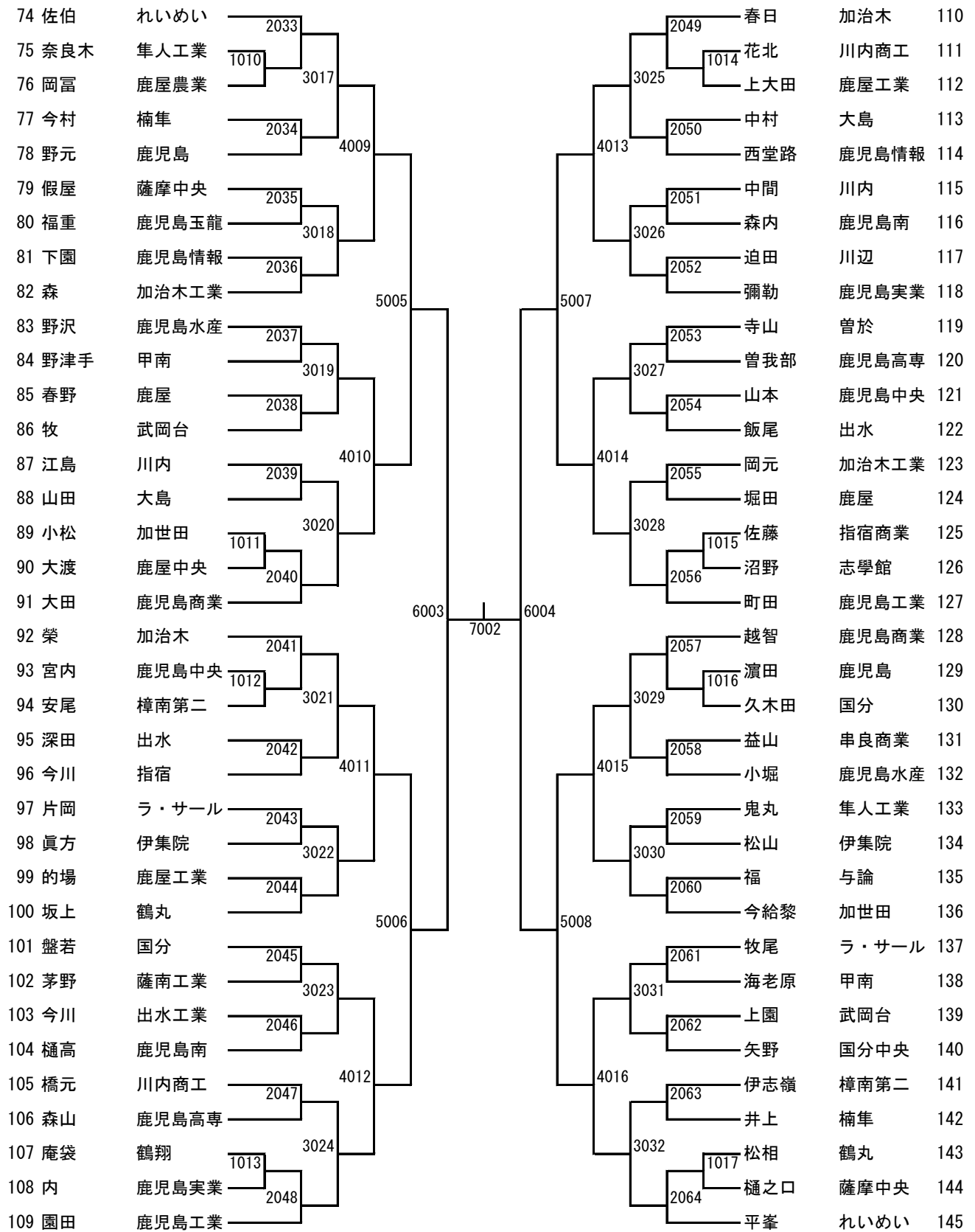

男子シングルス (3)

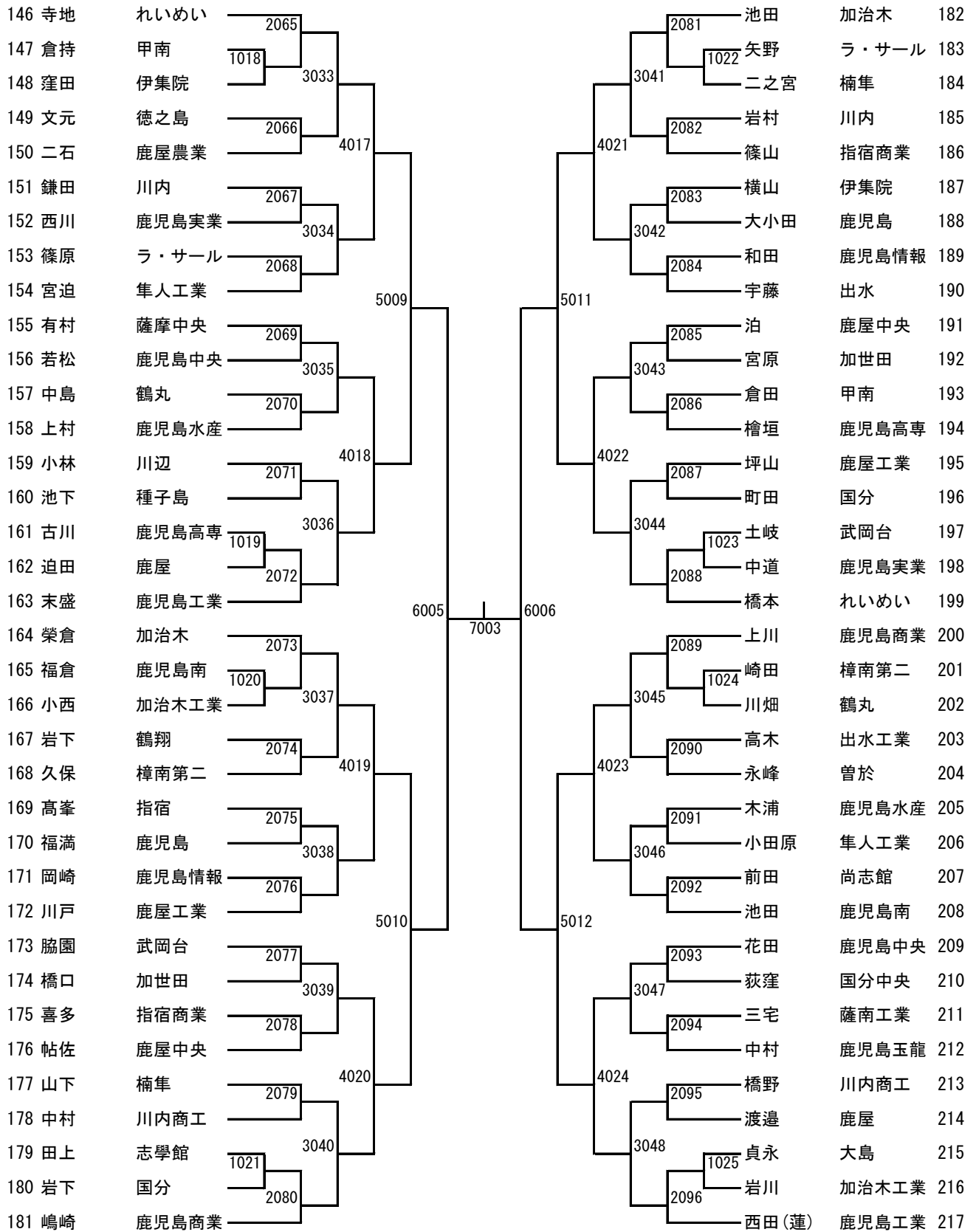

男子シングルス (4)

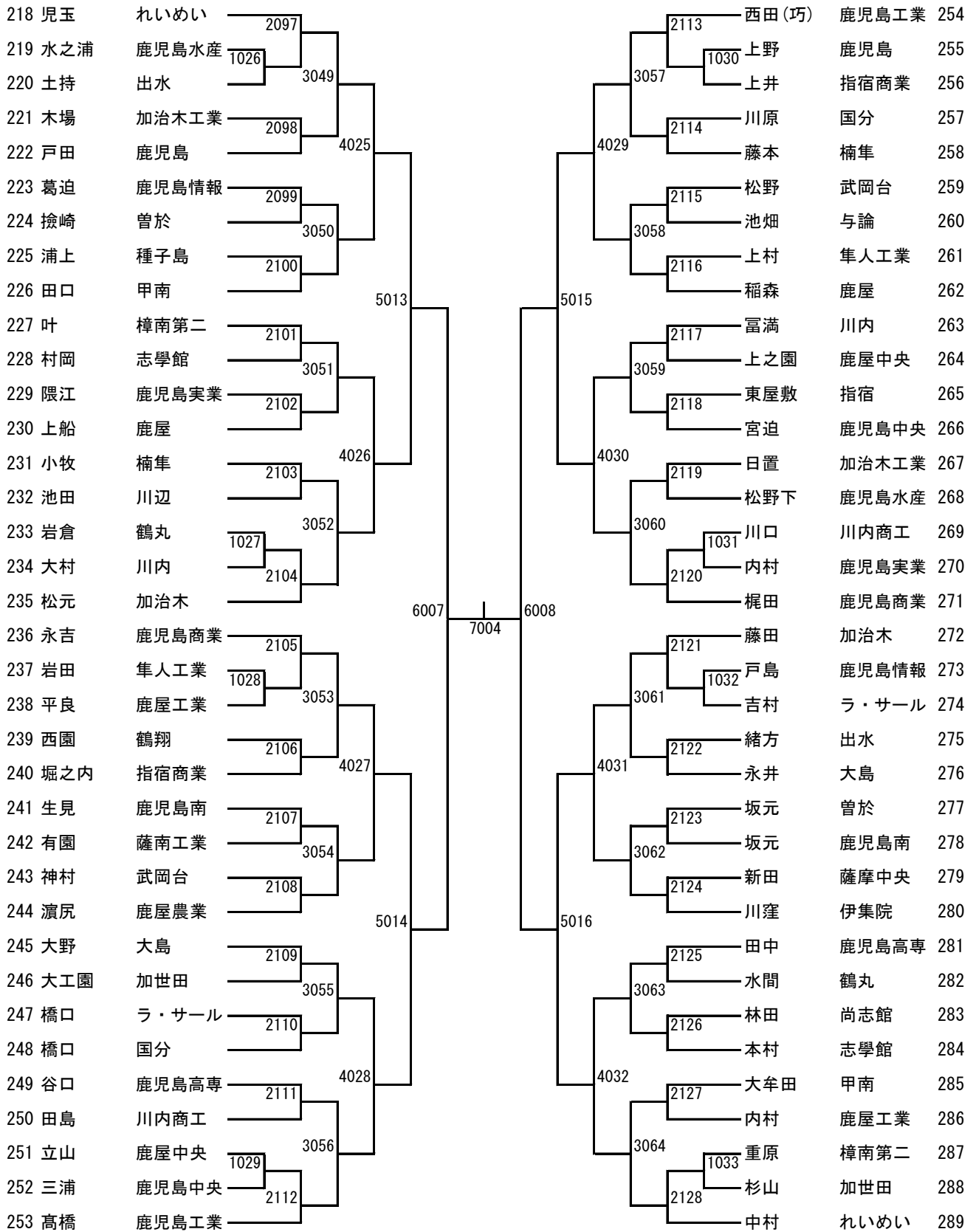

女子シングルス (1)

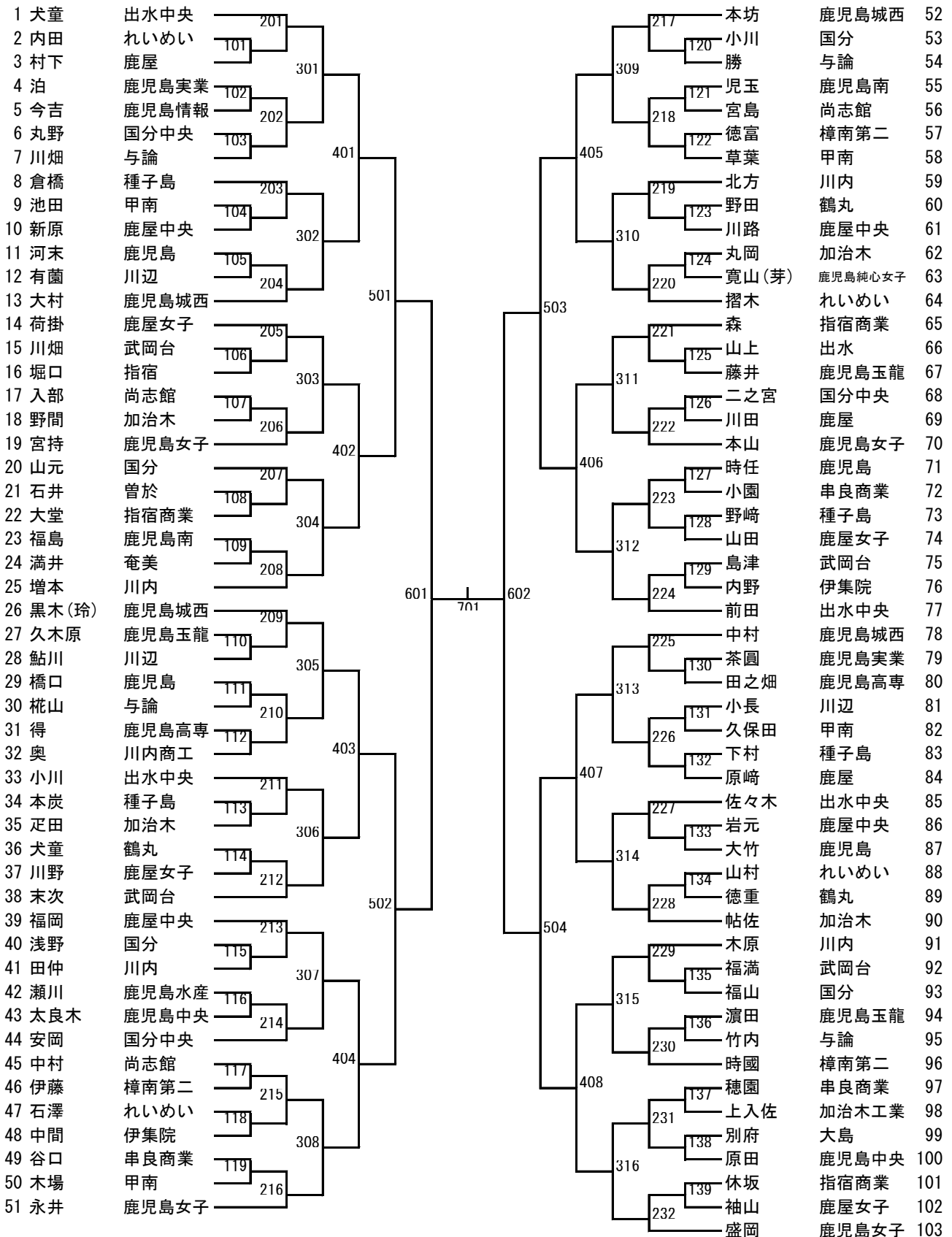

女子シングルス (2)

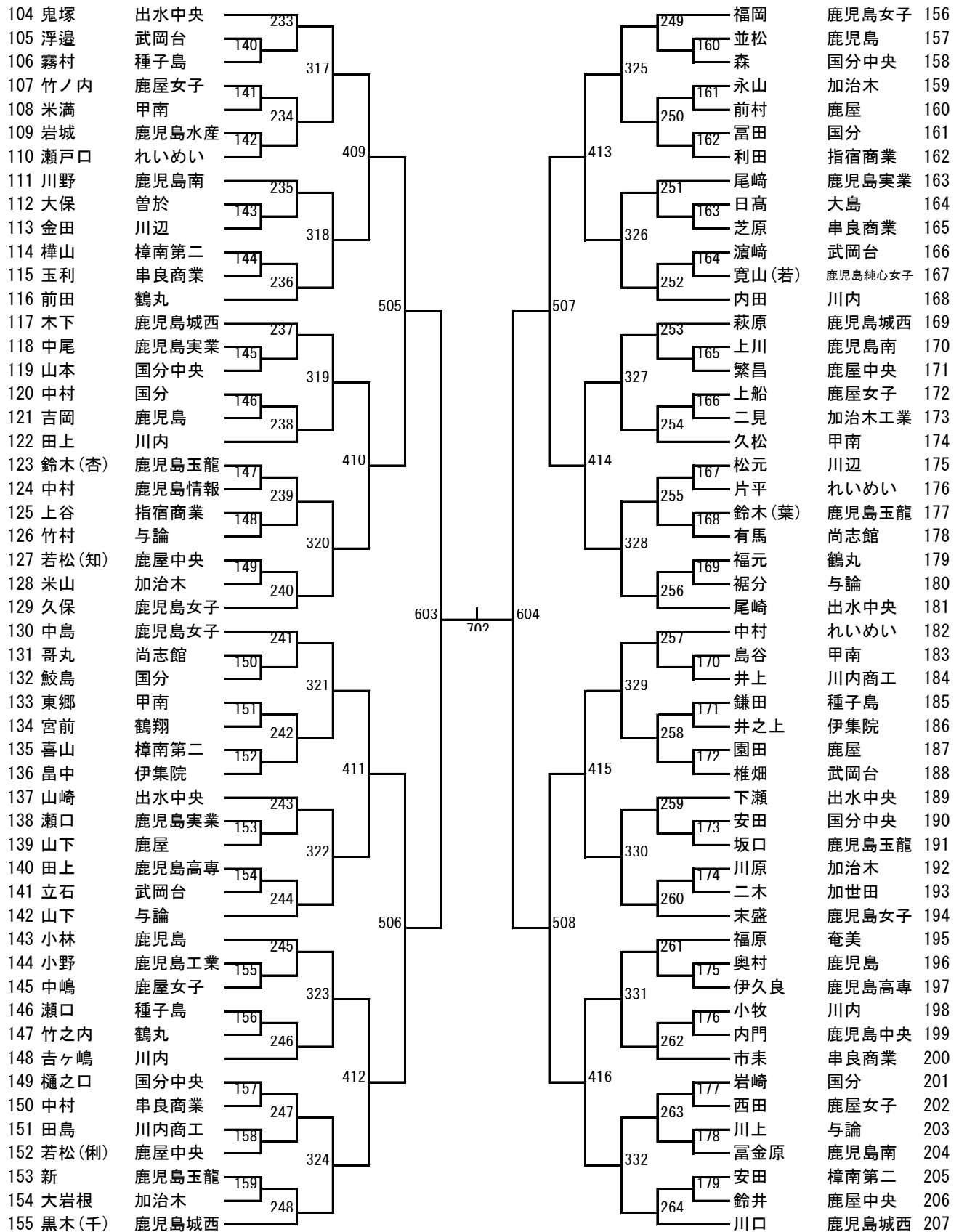

男子ダブルス (1)

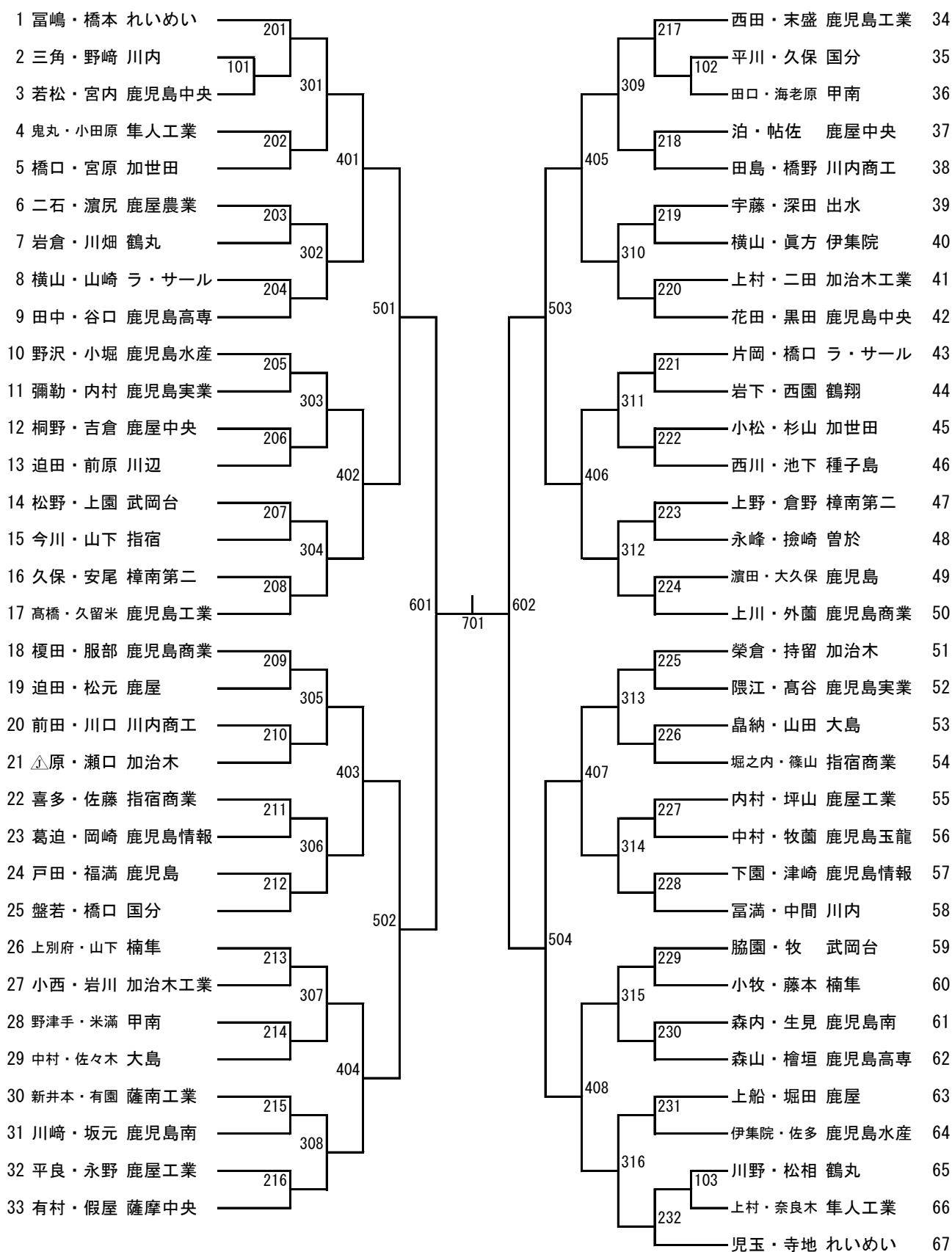

男子ダブルス（2）

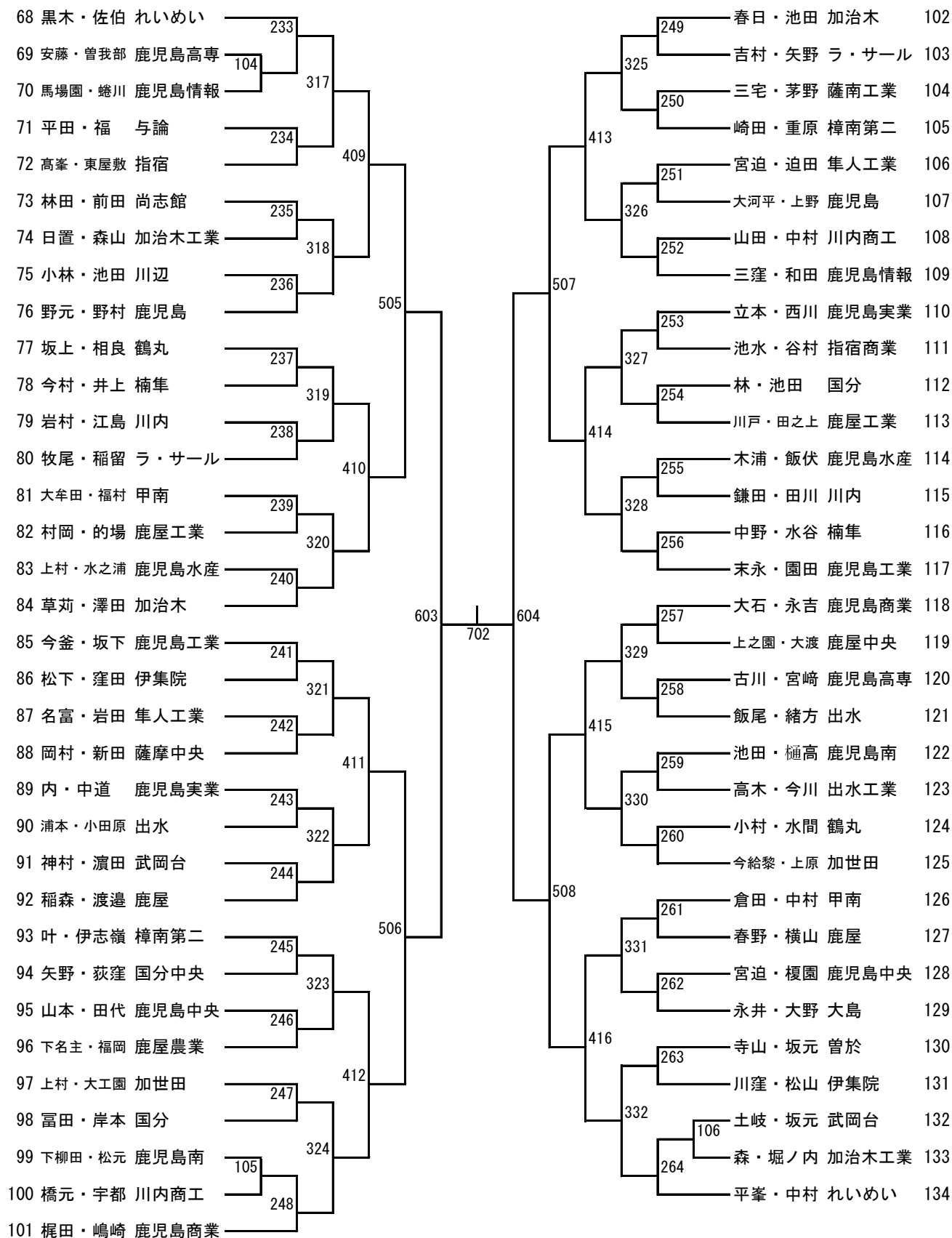

女子ダブルス

